

TIME

In TIME mode you can set time and calendar information.

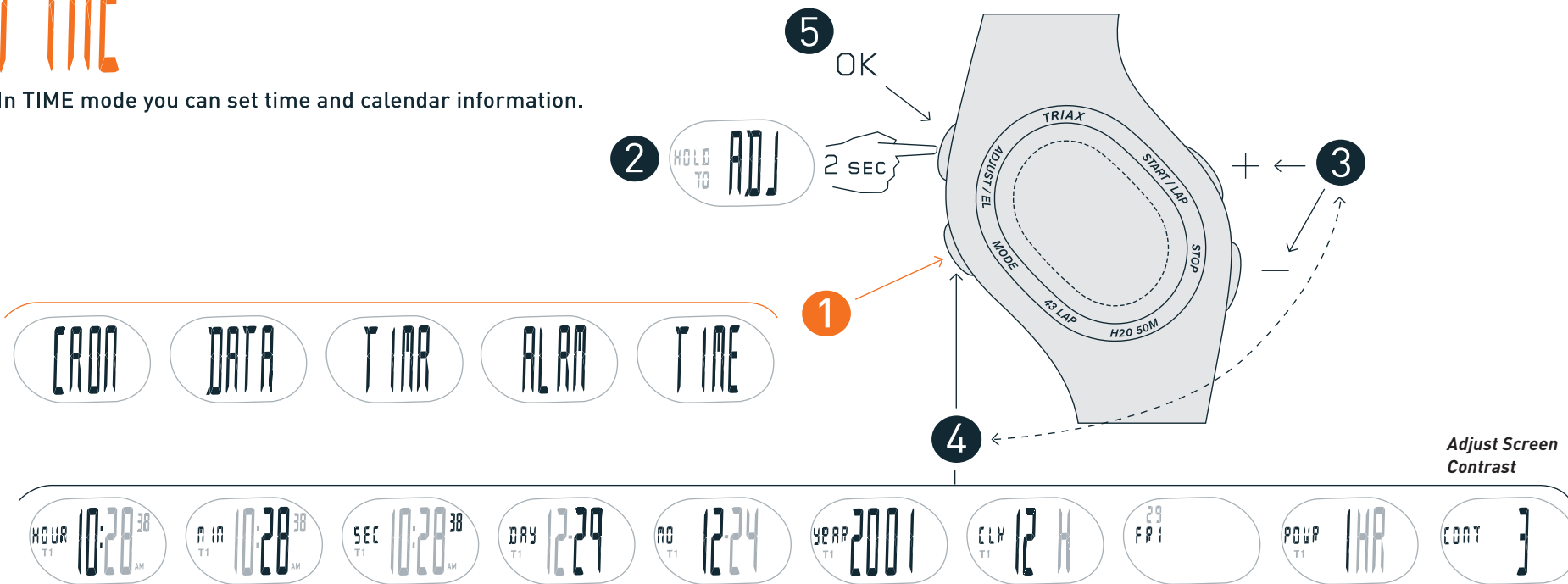

Adjust Screen Contrast

Powersave: Display shuts off after specified time to conserve battery. Press any button to turn watch on.

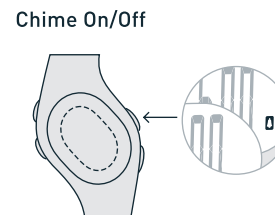
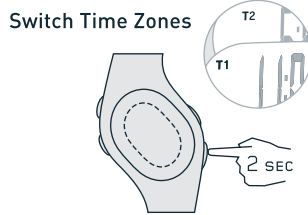
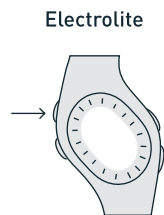
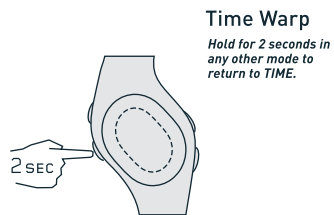



In CHRONOGRAPH mode you can capture lap, split and run times. Save your times for review in DATA mode.

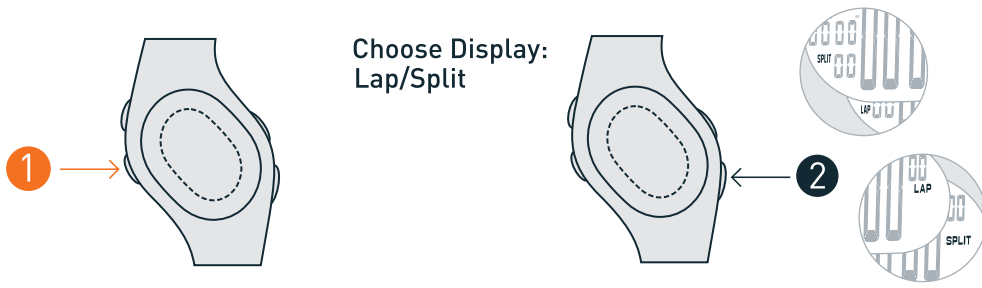

Set Distance to calculate pace

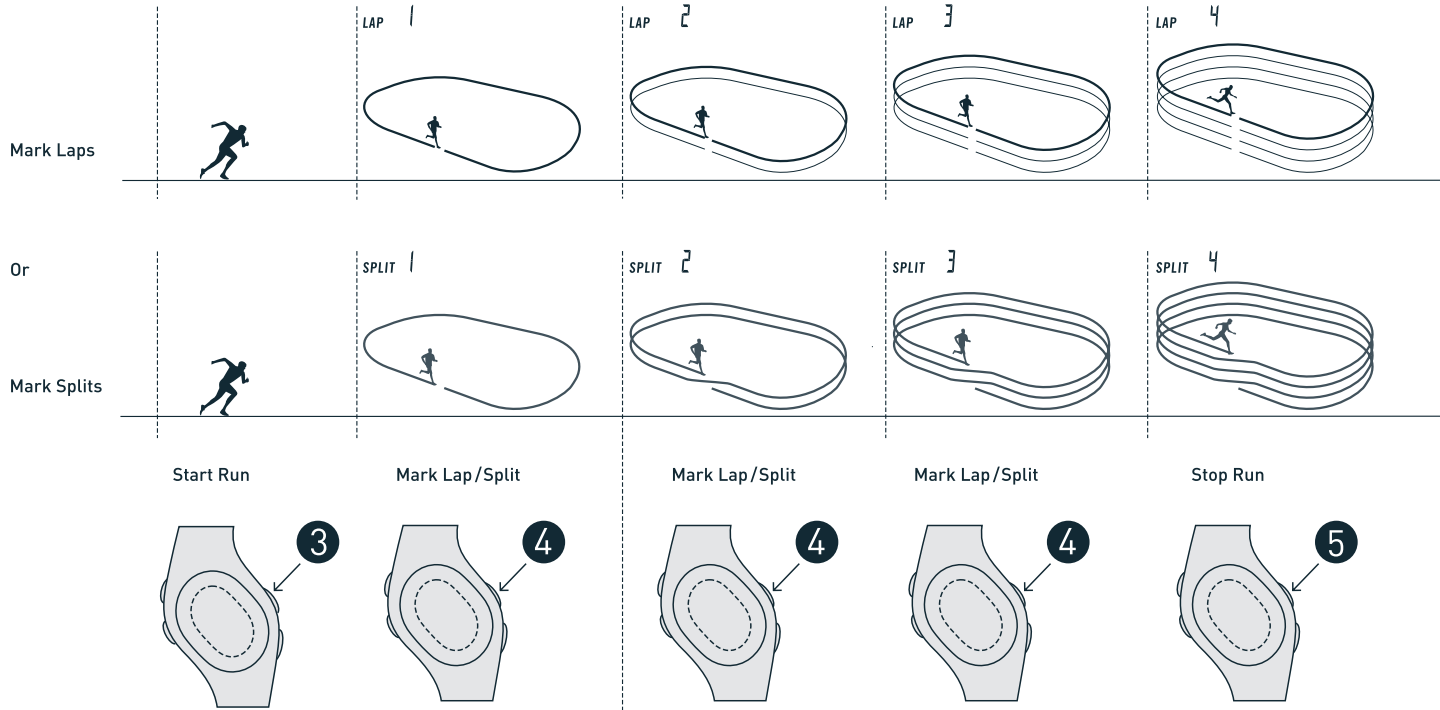
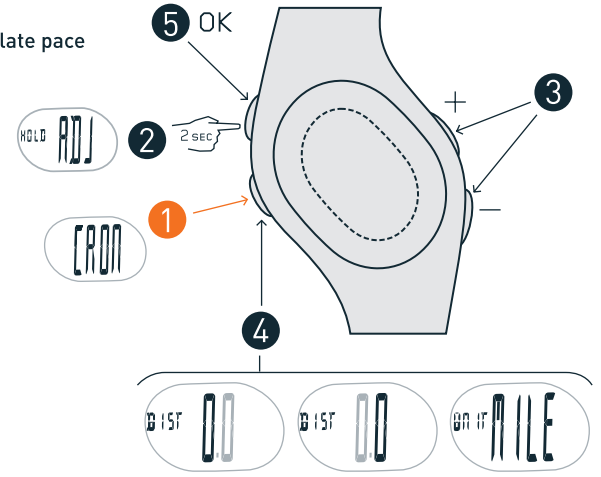

You have 8 seconds to read lap or split time.

Your run is automatic saved to DATA mode.

6 Reset

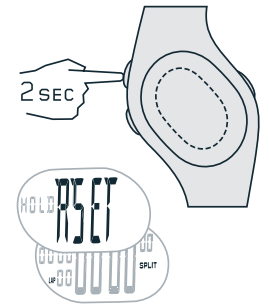

Information in DATA mode is erased upon starting a new race

ALARM

In ALARM mode you can set 2 alarms. Press any button to stop alarm. Alarm will automatically stop after 55 seconds.

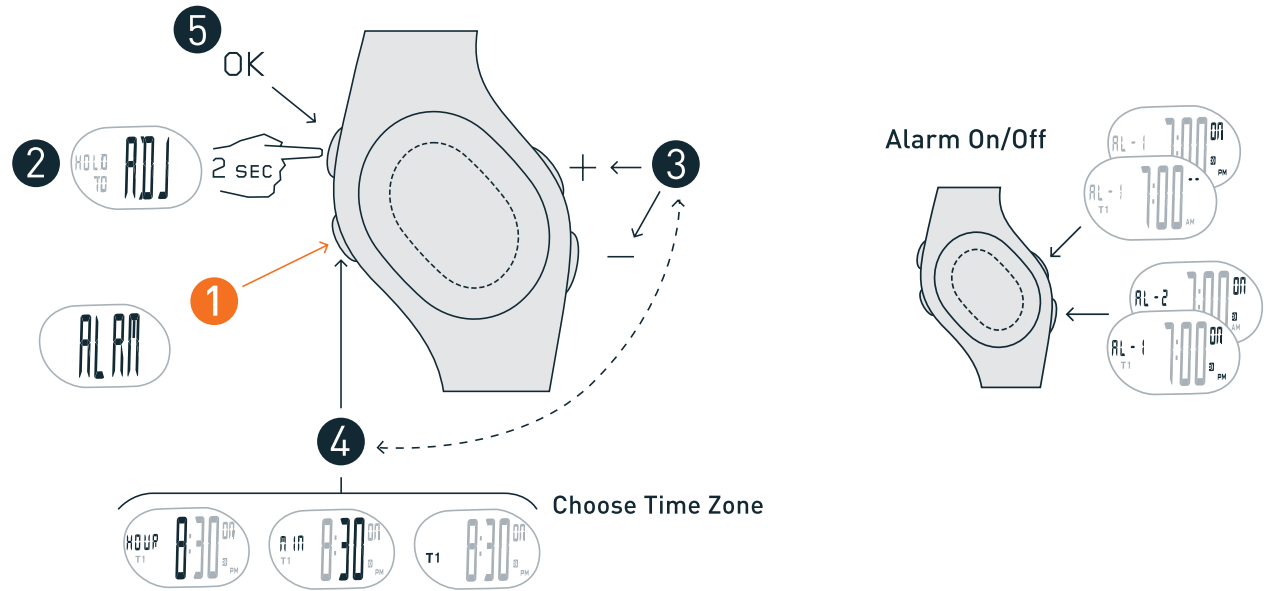

DATA

In DATA mode, you can review lap, split and run times. Record and reset your times in CHRONOGRAPH mode.

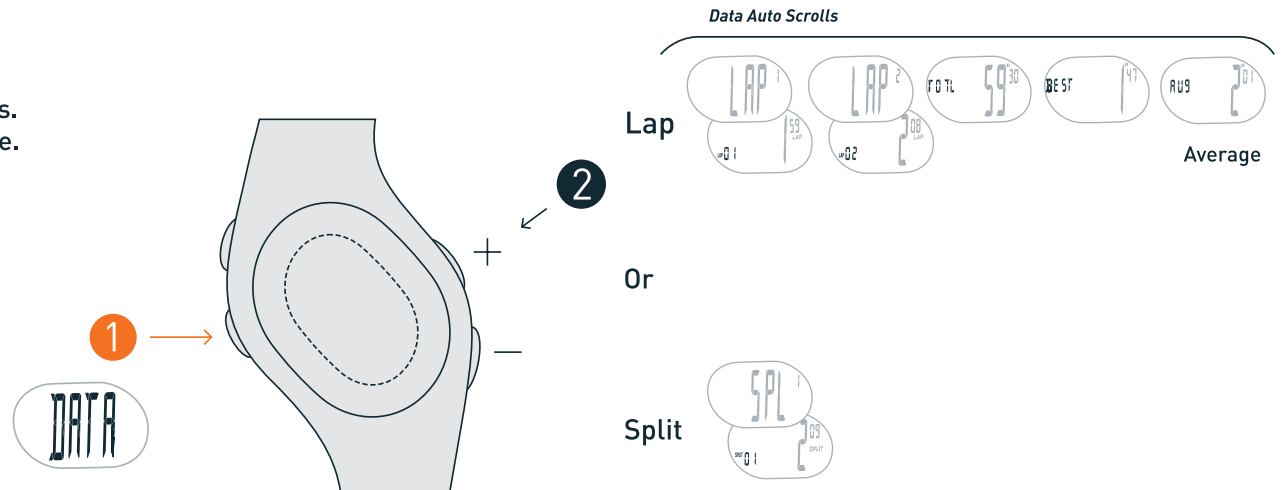

TIMER

In TIMER mode you can set a repeating timer for your workout.

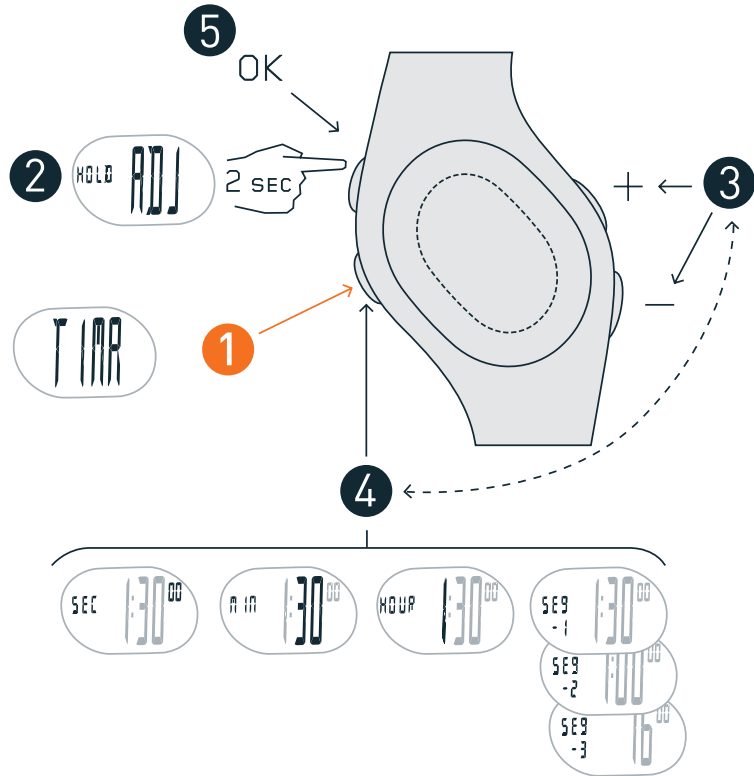

Start & Stop Countdown

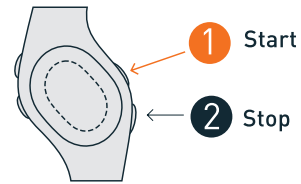

Cycle Segments

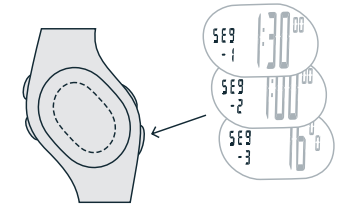

Reset Countdown

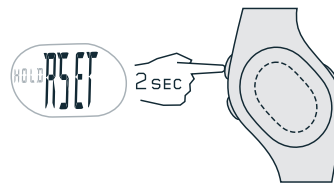

Clear All Segments

